



## Wilshire Planters Powder-Coated Steel Rectangle & Square

Wilshire Powder-Coated Steel Planters are available in powder-coated mild steel with a zinc-rich primer and stainless-steel base. Wilshire planters are engineered with minimal wall thickness to be light when installed on-structure but resist deformation.

# Wilshire Planters, Powder-Coated Steel - Rectangle & Square

## WILSHIRE PLANTERS, STEEL RECTANGLES & SQUARES

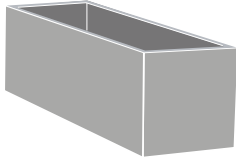

Rectangle

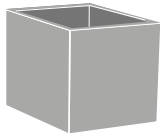

Square

## THE COMPLETE WILSHIRE COLLECTION For additional shapes and materials, visit [tournesol.com/collections/wilshire](https://tournesol.com/collections/wilshire)

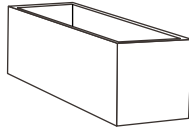

Rectangle

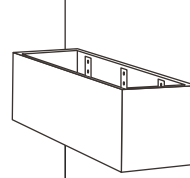

Hanging Box

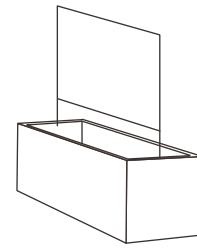

Trellis, Laser-Cut Screen

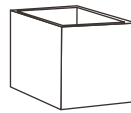

Square

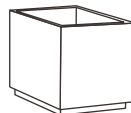

Toe Kick

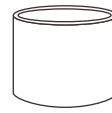

Round



Round with Toe Kick

## OPTIONS

Standard Wilshire Planters can be modified with a broad array of options without incurring custom charges. Options are limited to those products that can support them. Speak to a Tournesol Advisor to discuss which options will work with your project.



Irrigation

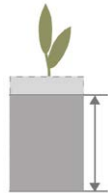

Change Dimension



Accessory Pockets

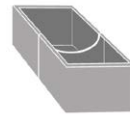

Scoops



Casters



Tourneseal



Drain Holes



Toe Kick



False Bottom



Tie Downs

# Wilshire Planters, Powder-Coated Steel - Rectangle & Square

## POWDER-COATED STEEL

Following fabrication, Wilshire Mild Steel Planters are thoroughly cleaned by white blasting, then the surface is treated with epoxy zinc-rich primer. After curing, the planter has a premium powder-coat finish applied.

## TOP LIP

Wilshire Planters in Steel and Aluminum come with a standard lip return.

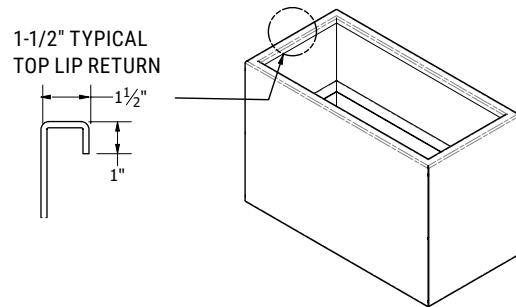

## BASE OPTION

Wilshire Planters are available with a toe kick option. Steel planters are available with a stainless steel base that inhibits rust where moisture pools. Aluminum Planters are fully welded.

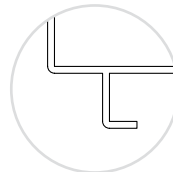

WWR-RE

Toe kick option  
2"H bottom reveal

## DRAINAGE

Drain Holes: Standard drain holes are 1-5/8" diameter, made free-of-charge at the factory.

# Wilshire Planters Powder-Coated Steel Rectangle & Square

- 12-gauge steel with stainless steel base
- Engineered to resist deformation
- Optional toe kick available
- Powder-coat over zinc-rich primer to reduce rusting
- Drain holes standard

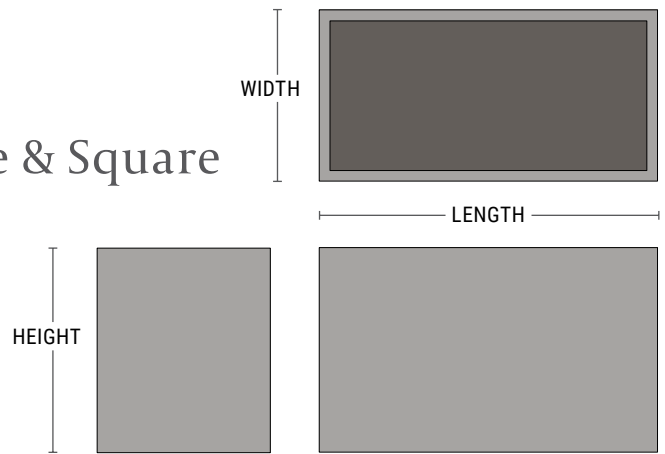

PRODUCT	SHAPE	LENGTH	WIDTH	HEIGHT	WEIGHT (LBS.)	VOLUME (CUBIC FT.)	INTERIOR TOP	IRRIGATION
WWR-CS1800	Square	18"	18"	20"	64 lbs.	3.5	15" x 15"	CWC-R1100
WVRT-CS1800	Square - tall	18"	18"	30"	85 lbs.	5.25	15" x 15"	CWM-R2020-MS
WWR-CS241012	Rectangle	24"	10"	12"	36 lbs.	1.47	21" x 7"	CWM-R1109-MS
WWR-CS241218	Rectangle	24"	12"	18"	52 lbs.	2.74	21" x 9"	CWM-R1614-MS
WWR-CS241818	Rectangle	24"	18"	18"	64 lbs.	4.14	21" x 15"	CWM-R2014-MS
WWR-CS241824	Rectangle	24"	18"	24"	86 lbs.	5.5	21" x 15"	CWM-R2014-MS
WWR-CS241830	Rectangle	24"	18"	30"	94 lbs.	7.08	21" x 15"	CWM-R2020-MS
WWR-CS242418	Square	24"	24"	18"	76 lbs.	5.53	21" x 21"	CWM-R2014-MS
WWR-CS2400	Square	24"	24"	24"	106 lbs.	7.5	21" x 21"	CWC-R1850/CWM-R1114-2k
WVRT-CS2400	Square - tall	24"	24"	48"	170 lbs.	15.25	21" x 21"	CWC-R1850/CWM-R1120-2k
WWR-CS3000	Square	30"	30"	27"	150 lbs.	13	27" x 27"	CWM-R1620-3K/CWM-1720-4K
WWR-CS361012	Rectangle	36"	10"	12"	51 lbs.	2.21	33" x 7"	CWM-R1109-2K
WWR-CS361218	Rectangle	36"	12"	18"	71 lbs.	4.13	33" x 9"	CWM-R1614-MS
WWR-CS361818	Rectangle	36"	18"	18"	85 lbs.	6.23	33" x 15"	CWM-R2014-MS
WWR-CS361824	Rectangle	36"	18"	24"	115 lbs.	8	33" x 15"	CWM-R2014-MS
WWR-CS361830	Rectangle	36"	18"	30"	134 lbs.	10.65	33" x 15"	CWM-R2020-MS
WWR-CS362418	Rectangle	36"	24"	18"	99 lbs.	8.32	33" x 21"	CWM-R2014-MS
WWR-CS362424	Rectangle	36"	24"	24"	132 lbs.	11	33" x 21"	CWM-R2914-MS
WWR-CS362430	Rectangle	36"	24"	30"	153 lbs.	14.24	33" x 21"	CWM-R2920-MS
WWR-CS362436	Rectangle	36"	24"	36"	175 lbs.	17.19	33" x 21"	CWM-R2920-MS

# Wilshire Planters Powder-Coated Steel Rectangle & Square

- 12-gauge steel with stainless steel base
- Engineered to resist deformation
- Optional toe kick available
- Powder-coat over zinc-rich primer to reduce rusting
- Drain holes standard

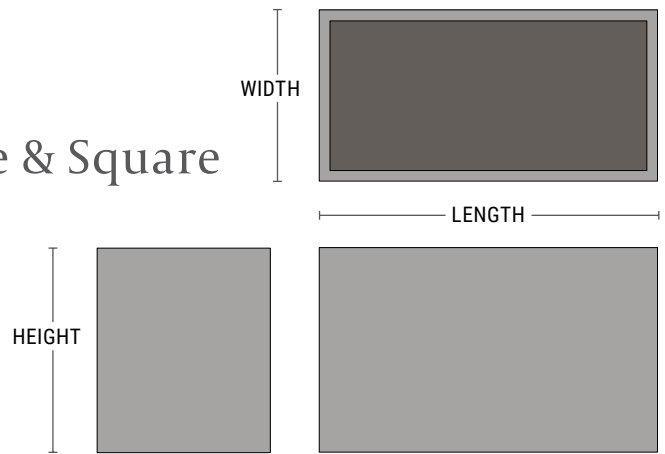

PRODUCT	SHAPE	LENGTH	WIDTH	HEIGHT	WEIGHT (LBS.)	VOLUME (CUBIC FT.)	INTERIOR TOP	IRRIGATION
WWR-CS362442	Rectangle	36"	24"	42"	196 lbs.	20.15	33" x 21"	CWM-R2920-MS
WWR-CS363018	Rectangle	36"	30"	18"	113 lbs.	10.42	33" x 27"	CWM-R2914-MS
WWR-CS363024	Rectangle	36"	30"	24"	137 lbs.	14.13	33" x 27"	CWM-R2920-MS
WWR-CS363030	Rectangle	36"	30"	30"	173 lbs.	17.5	33" x 27"	CWM-R2920-MS
WWR-CS363036	Rectangle	36"	30"	36"	196 lbs.	21.53	33" x 27"	CWM-R2920-MS
WWR-CS363042	Rectangle	36"	30"	42"	220 lbs.	25.23	33" x 27"	CWM-R2920-MS
WWR-CS363618	Square	36"	36"	18"	127 lbs.	12.52	33" x 33"	CWM-R2914-MS
WWR-CS363624	Square	36"	36"	24"	153 lbs.	16.97	33" x 33"	CWM-R2920-MS
WWR-CS3600	Square	36"	36"	30"	204 lbs.	21	33" x 33"	CWM-R1620-2K/CWM-1720-4K
WWR-CS363636	Rectangle	36"	36"	36"	218 lbs.	25.87	33" x 33"	CWM-R2920-MS
WWR-CS363642	Rectangle	36"	36"	42"	243 lbs.	30.31	33" x 33"	CWM-R2920-MS
WWR-CS4200	Square	42"	42"	36"	262 lbs.	35.25	39" x 39"	CWM-R1120-4K/CWM-1720-4K
WWR-CS481012	Rectangle	48"	10"	12"	65 lbs.	2.95	45" x 7"	CWM-R1109-3K
WWR-CS481218	Rectangle	48"	12"	18"	91 lbs.	5.51	45" x 9"	CWM-R1614-2K
WWR-CS481818	Rectangle	48"	18"	18"	107 lbs.	8.31	45" x 15"	CWM-R2014-2K
WWR-CS481824	Rectangle	48"	18"	24"	148 lbs.	11	45" x 15"	CWM-R2014-2k
WWR-CS481830	Rectangle	48"	18"	30"	166 lbs.	14.22	45" x 15"	CWM-R2020-2K
WWR-CS482418	Rectangle	48"	24"	18"	123 lbs.	11.12	45" x 21"	CWM-R2014-2K
WWR-CS482424	Rectangle	48"	24"	24"	169 lbs.	14.5	45" x 21"	CWM-R2014-2k
WWR-CS482430	Rectangle	48"	24"	30"	188 lbs.	19.01	45" x 21"	CWM-R2020-2k

# Wilshire Planters Powder-Coated Steel Rectangle & Square

- 12-gauge steel with stainless steel base
- Engineered to resist deformation
- Optional toe kick available
- Powder-coat over zinc-rich primer to reduce rusting
- Drain holes standard

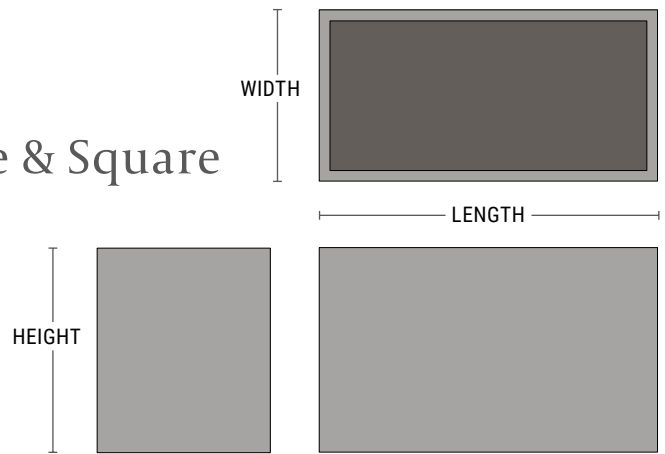

PRODUCT	SHAPE	LENGTH	WIDTH	HEIGHT	WEIGHT (LBS.)	VOLUME (CUBIC FT.)	INTERIOR TOP	IRRIGATION
WWR-CS482436	Rectangle	48"	24"	36"	213 lbs.	22.96	45" x 21"	CWM-R2020-2k
WWR-CS482442	Rectangle	48"	24"	42"	239 lbs.	26.91	45" x 21"	CWM-R2020-2k
WWR-CS483018	Rectangle	48"	30"	18"	139 lbs.	13.92	45" x 27"	CWM-R2014-2k
WWR-CS483024	Rectangle	48"	30"	24"	167 lbs.	18.86	45" x 27"	CWM-R2020-2k
WWR-CS483030	Rectangle	48"	30"	30"	219 lbs.	23.5	45" x 27"	CWM-R2020-2k
WWR-CS483036	Rectangle	48"	30"	36"	237 lbs.	28.75	45" x 27"	CWM-R2020-2k
WWR-CS483042	Rectangle	48"	30"	42"	265 lbs.	33.69	45" x 27"	CWM-R2020-2k
WWR-CS483618	Rectangle	48"	36"	18"	155 lbs.	16.72	45" x 33"	CWM-R2014-2k
WWR-CS483624	Rectangle	48"	36"	24"	185 lbs.	22.66	45" x 33"	CWM-R2020-2k
WWR-CS483630	Rectangle	48"	36"	30"	231 lbs.	28.6	45" x 33"	CWM-R2020-2k
WWR-CS483636	Rectangle	48"	36"	36"	261 lbs.	34.54	45" x 33"	CWM-R2020-2k
WWR-CS483642	Rectangle	48"	36"	42"	291 lbs.	40.48	45" x 33"	CWM-R2020-2k
WWR-CS484818	Rectangle	48"	48"	18"	187 lbs.	22.33	45" x 45"	CWM-R2014-2k
WWR-CS4824	Square	48"	48"	24"	239 lbs.	30.25	45" x 45"	CWM-R2014-4K/CWM-2914-4K
WWR-CS484830	Rectangle	48"	48"	30"	274 lbs.	38.19	45" x 45"	CWM-R2020-2k
WWR-CS4800	Square	48"	48"	36"	344 lbs.	45.5	45" x 45"	CWM-R2920-4k
WWR-CS484842	Square	48"	48"	42"	342 lbs.	54.05	45" x 45"	CWM-R2020-2k
WWR-CS601012	Rectangle	60"	10"	12"	79 lbs.	3.69	57" x 7"	CWM-R1109-3K
WWR-CS601218	Rectangle	60"	12"	18"	110 lbs.	6.89	57" x 9"	CWM-R1614-3K
WWR-CS601818	Rectangle	60"	18"	18"	128 lbs.	10.4	57" x 15"	CWM-R2014-2K

# Wilshire Planters Powder-Coated Steel Rectangle & Square

- 12-gauge steel with stainless steel base
- Engineered to resist deformation
- Optional toe kick available
- Powder-coat over zinc-rich primer to reduce rusting
- Drain holes standard

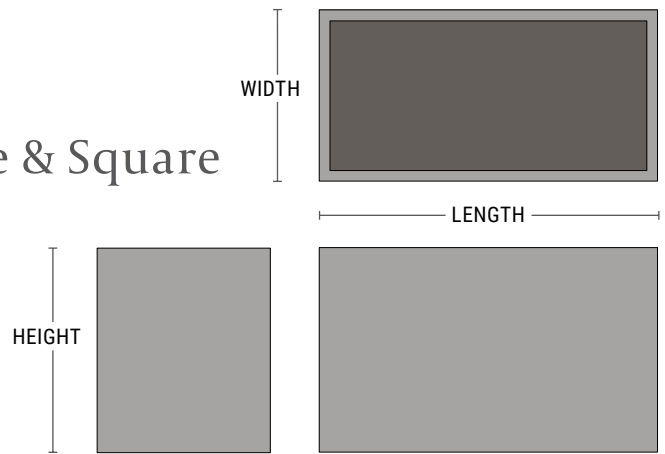

PRODUCT	SHAPE	LENGTH	WIDTH	HEIGHT	WEIGHT (LBS.)	VOLUME (CUBIC FT.)	INTERIOR TOP	IRRIGATION
WWR-CS601824	Rectangle	60"	18"	24"	177 lbs.	14	57" x 15"	CWM-R2014-2k
WWR-CS601830	Rectangle	60"	18"	30"	198 lbs.	17.79	57" x 15"	CWM-R2020-2K
WWR-CS602418	Rectangle	60"	24"	18"	146 lbs.	13.91	57" x 21"	CWM-R2014-2K
WWR-CS602424	Rectangle	60"	24"	24"	200 lbs.	18.5	57" x 21"	CWM-R2014-2k
WWR-CS602430	Rectangle	60"	24"	30"	222 lbs.	23.78	57" x 21"	CWM-R2020-2k
WWR-CS602436	Rectangle	60"	24"	36"	252 lbs.	28.72	57" x 21"	CWM-R2020-2k
WWR-CS602442	Rectangle	60"	24"	42"	298 lbs.	33.66	57" x 21"	CWM-R2020-2k
WWR-CS603018	Rectangle	60"	30"	18"	164 lbs.	17.41	57" x 27"	CWM-R2014-2k
WWR-CS603024	Rectangle	60"	30"	24"	197 lbs.	23.6	57" x 27"	CWM-R2020-2k
WWR-CS603030	Rectangle	60"	30"	30"	256 lbs.	29	57" x 27"	CWM-R2020-2k
WWR-CS603036	Rectangle	60"	30"	36"	278 lbs.	35.97	57" x 27"	CWM-R2020-2k
WWR-CS603042	Rectangle	60"	30"	42"	327 lbs.	42.15	57" x 27"	CWM-R2020-2k
WWR-CS603618	Rectangle	60"	36"	18"	183 lbs.	20.92	57" x 33"	CWM-R2014-2k
WWR-CS603624	Rectangle	60"	36"	24"	217 lbs.	28.35	57" x 33"	CWM-R2020-2k
WWR-CS603630	Rectangle	60"	36"	30"	269 lbs.	35.78	57" x 33"	CWM-R2020-2k
WWR-CS603636	Rectangle	60"	36"	36"	304 lbs.	43.21	57" x 33"	CWM-R2020-2k
WWR-CS603642	Rectangle	60"	36"	42"	356 lbs.	50.64	57" x 33"	CWM-R2020-2k
WWR-CS604818	Rectangle	60"	48"	18"	219 lbs.	27.94	57" x 45"	CWM-R2014-2k
WWR-CS604824	Rectangle	60"	48"	24"	257 lbs.	37.86	57" x 45"	CWM-R2020-2k
WWR-CS604830	Rectangle	60"	48"	30"	317 lbs.	47.78	57" x 45"	CWM-R2020-2k

# Wilshire Planters Powder-Coated Steel Rectangle & Square

- 12-gauge steel with stainless steel base
- Engineered to resist deformation
- Optional toe kick available
- Powder-coat over zinc-rich primer to reduce rusting
- Drain holes standard

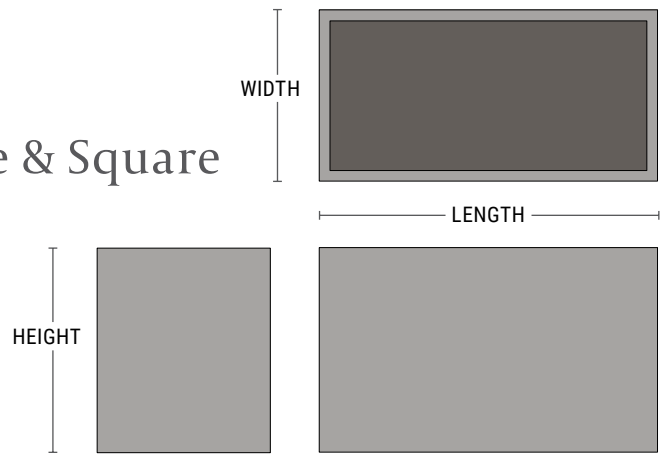

PRODUCT	SHAPE	LENGTH	WIDTH	HEIGHT	WEIGHT (LBS.)	VOLUME (CUBIC FT.)	INTERIOR TOP	IRRIGATION
WWR-CS604836	Rectangle	60"	48"	36"	355 lbs.	57.7	57" x 45"	CWM-R2020-2k
WWR-CS604842	Rectangle	60"	48"	42"	414 lbs.	67.62	57" x 45"	CWM-R2020-2k
WWR-CS6000	Square	60"	60"	42"	450 lbs.	84.5	57" x 57"	CWM-2920-4K
WWR-CS721012	Rectangle	72"	10"	12"	93 lbs.	4.43	69" x 7"	CWM-R1109-4K
WWR-CS721218	Rectangle	72"	12"	18"	129 lbs.	8.28	69" x 9"	CWM-R1614-3K
WWR-CS721818	Rectangle	72"	18"	18"	149 lbs.	12.49	69" x 15"	CWM-R2014-3K
WWR-CS721824	Rectangle	72"	18"	24"	210 lbs.	16.5	69" x 15"	CWM-R2014-3k
WWR-CS721830	Rectangle	72"	18"	30"	231 lbs.	21.36	69" x 15"	CWM-R2020-3K
WWR-CS722418	Rectangle	72"	24"	18"	170 lbs.	16.7	69" x 21"	CWM-R2014-3K
WWR-CS722424	Rectangle	72"	24"	24"	238 lbs.	22	69" x 21"	CWM-R2014-3k
WWR-CS722430	Rectangle	72"	24"	30"	257 lbs.	28.56	69" x 21"	CWM-R2020-3k
WWR-CS722436	Rectangle	72"	24"	36"	291 lbs.	34.49	69" x 21"	CWM-R2020-3k
WWR-CS722442	Rectangle	72"	24"	42"	343 lbs.	40.42	69" x 21"	CWM-R2020-3k
WWR-CS723018	Rectangle	72"	30"	18"	190 lbs.	20.91	69" x 27"	CWM-R2014-3k
WWR-CS723024	Rectangle	72"	30"	24"	226 lbs.	28.34	69" x 27"	CWM-R2020-3k
WWR-CS723030	Rectangle	72"	30"	30"	301 lbs.	35	69" x 27"	CWM-R2020-3k
WWR-CS723036	Rectangle	72"	30"	36"	319 lbs.	43.19	69" x 27"	CWM-R2020-3k
WWR-CS723042	Rectangle	72"	30"	42"	375 lbs.	50.61	69" x 27"	CWM-R2020-3k
WWR-CS723618	Rectangle	72"	36"	18"	210 lbs.	25.12	69" x 33"	CWM-R2014-3k
WWR-CS723624	Rectangle	72"	36"	24"	249 lbs.	34.04	69" x 33"	CWM-R2020-3k



# Wilshire Planters Powder-Coated Steel Rectangle & Square

- 12-gauge steel with stainless steel base
- Engineered to resist deformation
- Optional toe kick available
- Powder-coat over zinc-rich primer to reduce rusting
- Drain holes standard

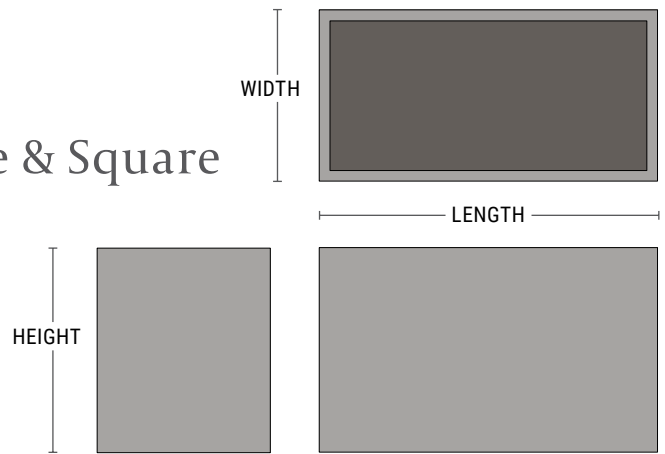

PRODUCT	SHAPE	LENGTH	WIDTH	HEIGHT	WEIGHT (LBS.)	VOLUME (CUBIC FT.)	INTERIOR TOP	IRRIGATION
WWR-CS723630	Rectangle	72"	36"	30"	308 lbs.	42.96	69" x 33"	CWM-R2020-3k
WWR-CS723636	Rectangle	72"	36"	36"	347 lbs.	51.89	69" x 33"	CWM-R2020-3k
WWR-CS723642	Rectangle	72"	36"	42"	406 lbs.	60.81	69" x 33"	CWM-R2020-3k
WWR-CS724818	Rectangle	72"	48"	18"	251 lbs.	33.54	69" x 45"	CWM-R2014-3k
WWR-CS724824	Rectangle	72"	48"	24"	294 lbs.	45.46	69" x 45"	CWM-R2020-3k
WWR-CS724830	Rectangle	72"	48"	30"	360 lbs.	57.37	69" x 45"	CWM-R2020-3k
WWR-CS724836	Rectangle	72"	48"	36"	403 lbs.	69.28	69" x 45"	CWM-R2020-3k
WWR-CS724842	Rectangle	72"	48"	42"	468 lbs.	81.19	69" x 45"	CWM-R2020-3k
WWR-CS7200	Square	72"	72"	30"	566 lbs.	122	69" x 69"	CWM-2920-4KE
WWR-CS961012	Rectangle	96"	10"	12"	121 lbs.	5.91	93" x 7"	CWM-R1109-5k
WWR-CS961218	Rectangle	96"	12"	18"	167 lbs.	11.04	93" x 9"	CWM-R1614-4K
WWR-CS961818	Rectangle	96"	18"	18"	192 lbs.	16.66	93" x 15"	CWM-R2014-3K
WWR-CS961824	Rectangle	96"	18"	24"	267 lbs.	22	93" x 15"	CWM-R2014-4k
WWR-CS961830	Rectangle	96"	18"	30"	317 lbs.	28.5	93" x 15"	CWM-R2020-3K
WWR-CS962418	Rectangle	96"	24"	18"	217 lbs.	22.28	93" x 21"	CWM-R2014-3K
WWR-CS962424	Rectangle	96"	24"	24"	299 lbs.	29.5	93" x 21"	CWM-R2014-4k
WWR-CS962430	Rectangle	96"	24"	30"	348 lbs.	38.11	93" x 21"	CWM-R2020-4k
WWR-CS962436	Rectangle	96"	24"	36"	391 lbs.	46.02	93" x 21"	CWM-R2020-4k
WWR-CS962442	Rectangle	96"	24"	42"	457 lbs.	53.93	93" x 21"	CWM-R2020-4k
WWR-CS963018	Rectangle	96"	30"	18"	241 lbs.	27.9	93" x 27"	CWM-R2014-4k

# Wilshire Planters Powder-Coated Steel Rectangle & Square

- 12-gauge steel with stainless steel base
- Engineered to resist deformation
- Optional toe kick available
- Powder-coat over zinc-rich primer to reduce rusting
- Drain holes standard

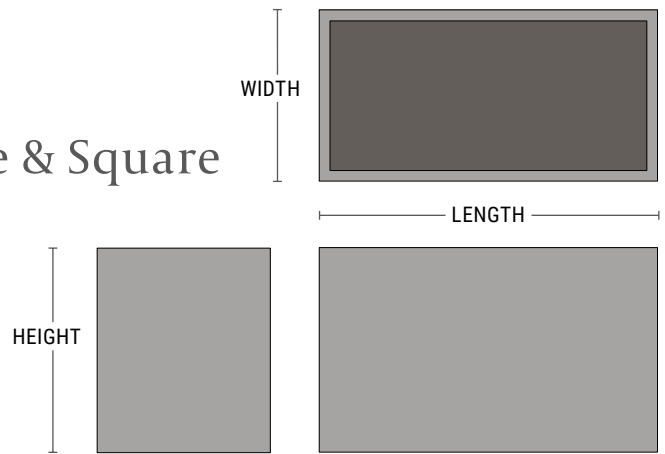

PRODUCT	SHAPE	LENGTH	WIDTH	HEIGHT	WEIGHT (LBS.)	VOLUME (CUBIC FT.)	INTERIOR TOP	IRRIGATION
WWR-CS963024	Rectangle	96"	30"	24"	311 lbs.	37.81	93" x 27"	CWM-R2020-4k
WWR-CS963030	Rectangle	96"	30"	30"	375 lbs.	46.5	93" x 27"	CWM-R2020-4k
WWR-CS963036	Rectangle	96"	30"	36"	425 lbs.	57.62	93" x 27"	CWM-R2020-4k
WWR-CS963042	Rectangle	96"	30"	42"	494 lbs.	67.53	93" x 27"	CWM-R2020-4k
WWR-CS963618	Rectangle	96"	36"	18"	266 lbs.	33.52	93" x 33"	CWM-R2014-4k
WWR-CS963624	Rectangle	96"	36"	24"	338 lbs.	45.42	93" x 33"	CWM-R2020-4k
WWR-CS963630	Rectangle	96"	36"	30"	411 lbs.	57.33	93" x 33"	CWM-R2020-4k
WWR-CS963636	Rectangle	96"	36"	36"	458 lbs.	69.23	93" x 33"	CWM-R2020-4k
WWR-CS963642	Rectangle	96"	36"	42"	531 lbs.	81.14	93" x 33"	CWM-R2020-4k
WWR-CS964818	Rectangle	96"	48"	18"	315 lbs.	44.76	93" x 45"	CWM-R2014-4k
WWR-CS964824	Rectangle	96"	48"	24"	394 lbs.	60.65	93" x 45"	CWM-R2020-4k
WWR-CS964830	Rectangle	96"	48"	30"	474 lbs.	76.55	93" x 45"	CWM-R2020-4k
WWR-CS964836	Rectangle	96"	48"	36"	525 lbs.	92.44	93" x 45"	CWM-R2020-4k
WWR-CS964842	Rectangle	96"	48"	42"	604 lbs.	108.34	93" x 45"	CWM-R2020-4k